



A FORGED TOOL



Catálogo

Equipos de Trabajo



📍 Avda. Andalucía, 139 - 18015 Granada (SPAIN)

☎ 958 208 900 📞 666 333 184

Extensiones Pedidos: 231 / 232 / 233 / 206

@ info@aftgrupo.com

🌐 www.aftgrupo.com



MAURER

**Carretilla plegable portátil
acero**

código 11090300 medida 35x43x94 unid. env. 1 ean 8 000071 839969

- Capacidad portante: 45 Kgs.
- Dimensiones: 94 x 43 cms.



MAURER

**Carretilla plegable portátil
aluminio**

código 11090250 unid. env. 1 ean 8 000071 917667

- Capacidad portante: 60 Kgs.
- Dimensiones: 101 x 39 cms.



MAURER

**Carretilla plegable portátil
aluminio**

código 11090255 unid. env. 1 ean 8 000071 917674

- Capacidad portante: 90 Kgs.
- Dimensiones: 96,5 x 49 cms.



MAURER

**Carretilla plegable portátil
aluminio**

código 11090200 unid. env. 1 ean 8 000071 868396

- Capacidad portante: 90 Kgs.
- Ruedas: Maticas goma-nylon 150 mm.
- Dimensiones: 39 x 39 x 109 cms.
- Plano de apoyo: 35 x 24,5 cms.
- Altura: 72 / 109 cms.
- Peso: 7 Kgs.



MAURER

**Carretilla plegable
con plataforma extensible**

código 11090210 unid. env. 1 ean 8 000071 868402

- Capacidad portante: 150 Kgs.
- Ruedas: Nylon 100 mm.
- Dimensiones: 71 x 85 cms.
- Plano de apoyo: 41 x 40 / 62 cms.
- Peso: 8,50 Kgs.



MAURER

Carretilla almacén aluminio rueda neumática

código	descripcion	unid. env.	ean
11090150		1	8 435450 414930

Alto:120 cms. x Ancho: 50 cms. x Fondo: 55 cms.



MAURER

Carretilla almacén rueda maciza llanta de plástico

código	descripcion	unid. env.	ean
11090100	llanta plástico	1	8 435450 414947

Alto:121 cms. x Ancho: 52 cms. x Fondo: 60 cms.

11090500	Tapón rueda recambio	1	8 435231 964760
----------	----------------------	---	-----------------

11090505	Mangos recambio	1	8 435231 964777
----------	-----------------	---	-----------------



MAURER

Carretilla almacén rueda neumática llanta de plástico

código	descripcion	unid. env.	ean
11090105	llanta plástico	1	8 435450 414954

Alto:121 cms. x Ancho: 52 cms. x Fondo: 60 cms.

11090500	Tapón rueda recambio	1	8 435231 964760
----------	----------------------	---	-----------------

11090505	Mangos recambio	1	8 435231 964777
----------	-----------------	---	-----------------

Carretillas Obra

WOLFPACK
LÍNEA PROFESIONAL

Carretilla obra verde metálica (desmontada)

código	descripcion	unid. env.	ean
11090001		1	8 435231 965194

11090510	Mangos recambio	1	8 435450 410024
----------	-----------------	---	-----------------

11090525	Cojinete de recambio	1	8 435450 411182
----------	----------------------	---	-----------------

WOLFPACK
LÍNEA PROFESIONAL

Carretilla obra amarilla metálica (desmontada)

código	descripcion	unid. env.	ean
11090003		1	8 435231 965187

11090510	Mangos recambio	1	8 435450 410024
----------	-----------------	---	-----------------

11090520	Cojinete de recambio 2 agujeros	1	8 435450 411175
----------	---------------------------------	---	-----------------

11090521	Cojinete de recambio 1 agujero	1	8 435450 422102
----------	--------------------------------	---	-----------------

WOLFPACK
LÍNEA PROFESIONAL

Carretilla obra / jardín plástico 100 litros (desmontada)

código	descripcion	unid. env.	ean
11090400	93929	80	8 000071 339294

11090402	Mangos recambio	10	8 000071 615426
----------	-----------------	----	-----------------





Rueda maciza amarilla llanta metálica para carretilla de obra

código medida unid. env. ean
11110068 Standard Ø 370 mm. 1 8 435231 940801

Llanta galvanizada con tornillos.



Rueda especial neumática llanta metálica para carretilla obra

código medida unid. env. ean
11110062 Ø 370 mm. 1 8 435450 413612



Cubierta rueda especial para carretilla obra

código medida unid. env. ean
11110080 Standard Ø 370 mm. 10 8 435450 414916

Cámara rueda especial para carretilla obra

código medida unid. env. ean
11110090 Standard Ø 370 mm. 10 8 435450 414923



Rueda para carretilla obra / jardín

código descripción unid. env. ean
11090401 Ø 400 mm. 1 8 000071 613590

Eje: Ø 19 mm.



Rueda neumática llanta plástico

código medida unid. env. ean
11110605 Ø 260 x 85 x 20 mm. 10 8 435450 414831



Rueda neumática llanta metálica

código medida unid. env. ean
11110650 Ø 260 x 85 x 20 mm. 10 8 435450 414817



Rueda neumática llanta metálica eje descentrado

código medida unid. env. ean
11110600 Ø 260 x 85 x 20 mm. 10 8 435450 414824



Rueda maciza para carretilla sacos llanta plástico

código medida unid. env. ean
11112415 Ø260. eje-20 mm. 1 8 435231 964470



Rueda maciza carretilla sacos llanta metálica

código medida unid. env. ean
11110608 Ø260. eje-20 mm. 10 8 435450 414602







Transpaleta de almacén ruedas de poliuretano





código capacidad portante unid. env. ean
11300100 2,50 Toneladas 1 8 435450 418327

- Estructura de acero especial de alta resistencia.
- Timón con barra envolvente de seguridad y diseño ergonómico.
- Palanca de maniobra accionada por bomba hidráulica.
- Cilindro hidráulico con accesorios antiaceite que aporta estanqueidad del líquido.
- Altura máxima: 200 mm.
- Altura mínima: 80 mm.
- Longitud externa: 550 mm.
- Longitud de las horquillas: 1.100 mm.
- Peso: 80 Kgs.









Rueda industrial goma negra sin eje

código						unid. env.	ean
11110063	150	20	37	58	170	20	8 435231 917698
11110064	200	20	50	58	200	10	8 435231 917704
11110114	250	20	50	58	250	8	8 422202 200798









Rueda industrial andamio

código				tipo		unid. env.	ean
11110150	200	234	46	Hembra	230	6	8 435231 903325
11110155	200	234	46	Macho	230	6	8 435231 962209





Rueda industrial goma negra placa fija

código									unid. env.	ean	
11110020	80	25	107	100x85	80x60	9	38	120	65	6	8 007554 029428
11110022	100	30	128	100x85	80x60	9	42	120	80	12	8 435231 917735
11110024	125	37,5	156	100x85	80x60	9	43	120	130	6	8 422202 202297
11110065	160	40	199	140x110	105x80	11	56	156	180	4	8 007554 028674









Rueda industrial goma negra con placa

código									unid. env.	ean	
11110023	125	37,5	156	100x85	80x60	9	43	120	170	15	8 435231 917735
11110025	140	37,5	176	100x85	80x60	9	42	120	200	12	8 422202 202297
11110059	160	40	199	140x110	105x80	11	56	156	250	1	8 007554 028674









Rueda industrial goma negra pasante

código						unid. env.	ean
11110820	80	32	35	110	70	1	8 435450 404528
11110821	100	32	39	127	90	1	8 435450 404535

Rueda industrial goma negra con placa

código									unid. env.	ean	
11110019	80	25	107	100x85	80x60	9	38	120	80	30	8 435231 903257
11110021	100	30	128	100x85	80x60	9	42	120	100	24	8 435231 917711

Rueda industrial goma negra placa con freno

código									unid. env.	ean	
11112019	80	25	107	100x85	80x60	9	38	120	80	30	8 435231 914536
11110800	100	32	128	100x80	80x60	13x9	-	90	1	8 435450 404474	



Rueda industrial goma gris con placa

código										unid.	env.	ean
11110835	80	30	112	100x80	80x60	9	-	-	50	1		
11110001	100	30	128	100x85	80x60	9	42	120	75	24		



Rueda industrial goma gris con placa y freno

código										unid.	env.	ean
11110845	80	30	112	100x80	80x60	9	-	-	50	1		
11112001	100	30	128	100x85	80x60	9	42	120	75	24		



Rueda industrial goma gris pasante

código										unid.	env.	ean
11110840	80	30	110	35	-	-	-	50	1			
11110002	100	30	128	12	80	42	120	75	30			



Rueda industrial goma gris pasante con freno

código										unid.	env.	ean
11110850	80	30	110	35	-	-	-	50	1			
11112002	100	30	128	12	80	42	120	75	24			



Rueda industrial nylon con placa

código										unid.	env.	ean
11110027	80	30	107	100x85	80x60	9	38	120	180	30		
11110029	100	30	128	100x85	80x60	9	42	120	200	24		
11110031	125	40	156	100x85	80x60	9	43	120	220	12		
11110033	150	45	194	140x110	105x80	11	56	156	300	4		



Rueda industrial nylon placa fija

código										unid.	env.	ean
11110028	80	30	107	100x85	80x60	9	38	120	180	6		
11110030	100	30	128	100x85	80x60	9	42	120	200	6		
11110032	125	40	156	100x85	80x60	9	43	120	220	6		
11110034	150	45	194	140x110	105x80	11	56	156	300	4		



Rueda industrial nylon pasante

código										unid.	env.	ean
11110815	80	30	35	108	100	1				1		
11110816	100	32	39	127	150	1				1		



Rueda industrial nylon placa con freno

código										unid.	env.	ean
11110805	80	30	110	100x80	13x9	100	1			1		
11110810	100	32	128	100x80	13x9	150	1			1		



Rueda industrial poliuretano con placa

código									unid. env.	ean
11112300	80x30	110	100x80	80x60	13x9	35	100	30	8 435231 917827	
11112310	100x30	128	100x80	80x60	13x9	39	120	24	8 435231 912556	
11112312	125x35	152	100x80	80x60	13x9	35	140	15	8 435231 912570	



Rueda industrial poliuretano con placa y freno

código									unid. env.	ean
11112340	80x30	110	100x80	80x60	13x9	35	100	24	8 435231 918084	
11112350	100x30	128	100x80	80x60	13x9	39	120	24	8 435231 918091	
11112352	125x35	152	100x80	80x60	13x9	35	140	15	8 435231 918107	



Rueda industrial poliuretano fija

código									unid. env.	ean
11112320	80x30	110	100x84	80x60	16x9	35	100	30	8 435231 917797	
11112330	100x30	128	100x84	80x60	16x9	39	120	24	8 435231 917742	
11112332	125x35	152	100x84	80x60	16x9	35	140	15	8 435231 917766	



Rueda poliuretano pasante con freno

código									unid. env.	ean
11112470	60x17	73	25	8,2	50	4	8 435231 917841			



Rueda poliuretano con placa

código									unid. env.	ean
11112360	40x16	57,5	46x36	34x24	5,2	24	30	4	8 435231 917674	
11112380	60x17	80	70x55	54x38	7	27	40	4	8 435231 917681	



Rueda poliuretano con placa y freno

código									unid. env.	ean
11112440	60x17	80	70x55	54x38	7	25	50	4	8 435231 917858	



Rueda poliuretano pasante

código									unid. env.	ean
11112390	40x16	55,5	24	8,2	30	4	8 435231 917650			
11112410	60x17	73	25	10,5	50	4	8 435231 917667			



Rueda polyamida pasante



8 435231 916219

código	∅					unidad. env.
11110039	30	16	48	M 8	15	200
11110040	40	17	58	M 8	22	200
11110008	50	18	67	M 10	35	20
11110041	60	18	78	M 10	40	10



Rueda polyamida con placa



8 435231 916158

código	∅					unidad. env.
11110007	30	16	51	46x36 34x24	15	20
11110037	40	17	58	46x36 34x24	22	20
11110009	50	18	72	70x55 54x38	35	10
11110038	60	18	81	70x55 54x38	40	10



Rueda goma gris pasante

goma (especial carros)

código						unidad. env.	ean
11110110	50	18	67	18 M10	22	20	8 435231 916233
11110003	60	18	78	18 M10	25	10	8 435231 916240



Rueda industrial goma gris con placa

código						unidad. env.	ean
11110057	40	16	58	46x36 34x24	17	4	8 435231 903301
11110010	60	18	81	70x55 54x38	25	4	8 435231 903295



Rueda industrial doble poliamida gris pasante con freno

código						unidad. env.	ean
11110860	50	18	28	71 70	70	1	8 435450 404610



Rueda doméstica doble poliamida gris con placa y freno

código						unidad. env.	ean
11110830	50	18	28	71 60x60 43x43	70	1	8 435450 404559



Rueda doméstica doble poliamida gris con placa

código						unidad. env.	ean
11110825	50	18	28	71 60x60 43x43	70	1	8 435450 404542



Rueda doméstica doble poliamida gris pasante

código						unidad. env.	ean
11110855	50	18	32	71 70	70	1	8 435450 404603



Rueda domestica poliamida negra fija

código									unid. env.	ean
11110012	60	22	85	60x60	45x45	6	27	60	24	8 007554 024720

**Rueda domestica poliamida negra con placa**

código									unid. env.	ean
11110052	60	22	85	60x60	45x45	6	27	60	24	8 007554 024690

**Rueda domestica nylon negro espiga**

código	Ø rueda	espiga roscada	unid. env.	ean
11110117	45 mm.	8 x 15 mm.	4	8 435231 916257
11111025	50 mm.	8 x 15 mm.	4	8 435450 404627

**Rueda domestica nylon negro con placa**

código	Ø rueda	medida pletina	unid. env.	ean
11110115	40 mm.	38 x 38 mm.	4	8 435231 916141
11111005	50 mm.	38 x 38 mm.	4	8 000071 871730

**Rueda domestica nylon negro espiga**

código					unid. env.	ean
11110106	50	62	M 8x26	50	4	8 435231 916264

**Rueda domestica goma negra esfera placa**

código	Ø rueda	medida pletina	unid. env.	ean
11111070	40 mm.	38 x 38 mm.	4	8 000071 871761
11111075	50 mm.	38 x 38 mm.	4	8 000071 871778

**Rueda domestica goma negra esfera espiga**

código	Ø rueda	espiga roscada	unid. env.	ean
11111050	40 mm.	8 mm.	4	8 000071 871747
11111055	50 mm.	10 mm.	4	8 000071 871754

**Rueda doméstica poliamida gris espiga**

código						unid. env.	ean
11110056	30	48	15	10 x 33	15	200	8 435231 916387





peldaño
30 x 30 mm



MAURER

Escalera aluminio industrial 1 tramo

código	nº peldaños	altura cms.	peso kgs.	sección mm.	unid. env.	ean
23020592	10	296	5,0	56	1	3 178740 005450
23020594	12	353	5,9	56	1	3 178740 005467
23020596	14	409	7,4	60	1	3 178740 005474

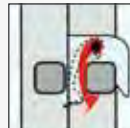

peldaño
30 x 30 mm



MAURER

Escalera aluminio industrial 2 tramos

código	nº peldaños	altura cms.	altura cms. extendida	peso kgs.	sección mm.	unid. env.
23020599	7+7	207	348	8,2	56	1
23020600	8+8	235	404	9,2	56	1
23020610	10+10	291	488	12,2	66	1
23020620	12+12	348	600	17,4	79,5	1
23020630	14+14	404	712	20,2	79,5	1
23020632	15+15	432	768	22,2	79,5	1

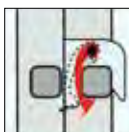

peldaño
30 x 30 mm



MAURER

Escalera aluminio industrial 3 tramos

código	nº peldaños	altura cms. plegada	altura cms. tramo	altura cms. extendida	peso kgs.	sección mm.	unid. env.
23020640	7+7+7	209	343	490	13,4	66	1
23020650	8+8+8	237	371	518	15,2	66	1
23020660	9+9+9	266	428	602	18,7	76	1
23020670	10+10+10	293	484	686	21,3	79,5	1
23020680	12+12+12	349	568	798	25,7	79,5	1



peldaño
30 x 30 mm



MAURER

Escalera aluminio industrial 2 tramos mecánica

código	nº peldaños	peso kgs.	sección mm.	unid. env.	ean
23020690	14+14	18,5	66	1	3 178740 005542

Altura plegada: 409 cms.
Altura extendida: 689 cms.

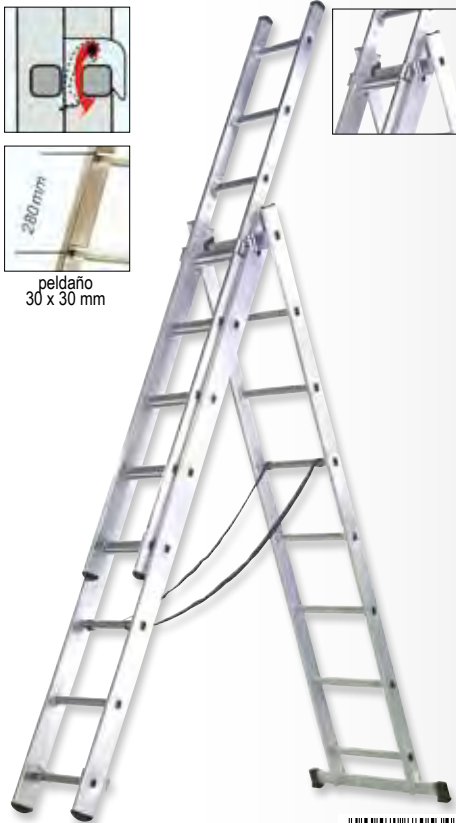

peldaño
30 x 30 mm



peldaño
30 x 30 mm



ALTURA
EXTENDIDA:
10 mts.

MAURER

Escalera aluminio 3 tramos

código	nº peldaños	altura cms plegada	altura cms extendida	peso kgs.	unid. env.
23020009	7+7+7	200	300	420	9,1
23020006	8+8+8	227	317	507	10,6
23020007	9+9+9	255	345	591	12,5
23020008	10+10+10	283	373	647	14,6
23020010	12+12+12	339	429	731	17,3



MAURER

Escalera aluminio 2 tramos mecánica

código	nº peldaños	altura cms plegada	altura cms extendida	peso kgs.	unid. env.	ean
23020015	14+14	227	317	507	10,6	3 178740 048501

Altura plegada: 396 cms.
Altura extendida: 704 cms.

MAURER

Escalera aluminio industrial pronor con travesaño

código	nº peldaños	altura cms plegada	altura cms extendida	peso kgs.	unid. env.	ean
23021052	14+14+14	150	1	3 178740 029012		

Altura plegada: 405 cms.
Altura tija: 674 cms.
Altura extendida: 1000 cms.

MAURER

Travesaño escalera

código	unid. env.	ean
23020112 Para 23020001 / 23020002	1	8 435231 911627
23020114 Para 23020005	1	



peldaño
30 x 30 mm

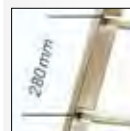
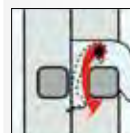

peldaño
30 x 30 mm

MAURER

Escalera aluminio 1 tramo

código	nº peldaños	altura cms plegada	altura cms extendida	peso kgs.	unid. env.	ean
23020200	4 x 3	14,5	1	3 178740 049249		

Altura plegada: 101 cms.
Altura extendida: 361 cms.

código	nº peldaños	altura cms plegada	altura cms extendida	peso kgs.	sección mm.	unid. env.	ean
23020020	8	227	3,0	56	1	3 178740 105167	
23020021	10	283	3,9	56	1	3 178740 038960	
23020022	14	395	6,0	56	1	3 178740 049256	

MAURER

Escalera aluminio 2 tramos

código	nº peldaños	altura cms plegada	altura cms extendida	peso kgs.	unid. env.
23020001	7+7	200	340	6,4	1
23020002	8+8	228	396	7,0	1
23020005	10+10	284	480	10,0	1
23020004	12+12	340	592	12,0	1



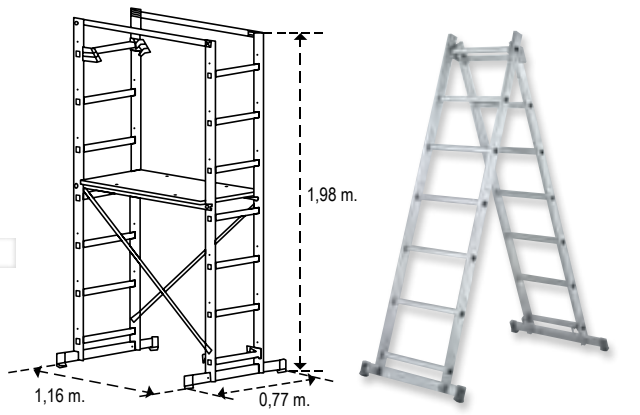

2,95 m.

13,2 Kg.

MAURER

**Kit andamio multifunción aluminio
Uso doméstico**

código	descripción	unid. env.	ean
23020030	7 + 7 peldaños	1	3 178740 032807

- Características
- Tablero de 0,97 x 0,50 mts.
- Fácil montaje por una sola persona.
- Gran ligereza y movilidad.
- Uso en exteriores.
- 2,95 metros de altura máxima de trabajo.
- Resistencia máxima 150 kgs.



MAURER

**Kit andamio "modulium" 5 mts
uso doméstico**

código	Altura de trabajo	unid. env.	ean
23020025	5 mts.	1	3 178740 039035

- Altura de trabajo: 5 mts.
- Altura máxima de la plataforma: 2,67 mts.
- Peso: 25 kgs.
- Dimensiones de la plataforma: 1,29 x 0,45 mts.
- Desplazamiento sobre dos ruedas direccionales de 100 mm. de diámetro
- Carga de utilización máxima: 150 kgs.





Escalera telescópica mixta

código	nº peldaños	altura cms plegada	altura cms tijera	altura cms extendida	unid.	env.	ean
23020450	4 + 4	115	194	378	1		8 435231 911443
23020460	4 + 5	141	220	430	1		8 435231 911450
23020470	5 + 5	141	246	482	1		8 435231 911467

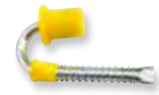

Gancho y tope para escalera telescópica mixta

código	unid.	env.	ean
23020475	1		8 435231 936613

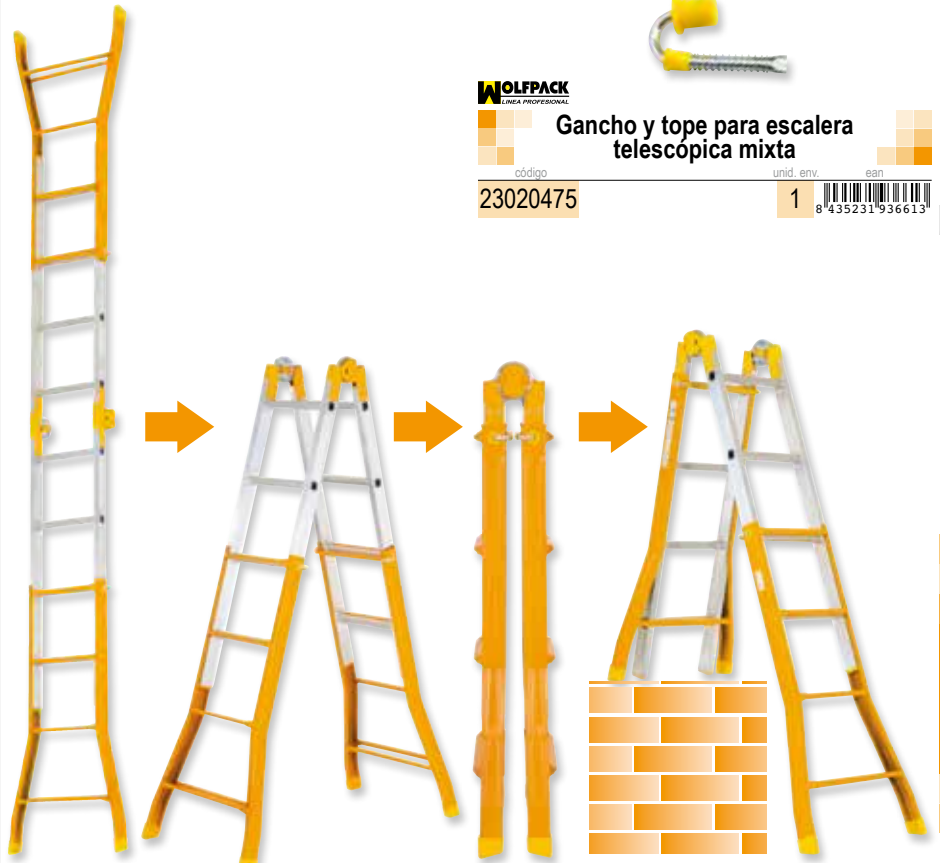

ENTENDIDA
1/1

TIJERA
1/2

PLEGADA
1/3

ASIMÉTRICA

Escalera Telescópica Multifunción Aluminio



Escalera telescópica aluminio

código	nº peldaños	altura cms plegada	altura cms tijera	altura cms extendida	unid.	env.	ean
23020400	4 + 4	114	192	380	1		8 000071 886574
23020410	4 + 5	140	283	442	1		8 000071 886581
23020420	5 + 5	143	247	485	1		8 000071 886598

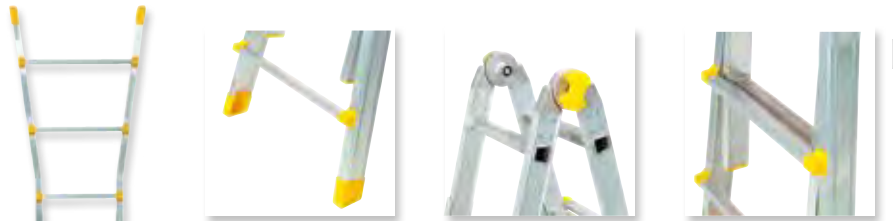

Su sistema de PERFILES TELESCÓPICOS y ARTICULACIÓN CENTRAL le permiten quedar TOTALMENTE PLEGADA A MÁS DE 1/3 DE SU TAMAÑO TOTALMENTE EXTENDIDA. Pudiendo ser fácilmente transportada en maleteros, etc.



ENTENDIDA
1/1

TIJERA
1/2

PLEGADA
1/3

ASIMÉTRICA



MAURER

Escalera aluminio en 131 doméstica / profesional

código	Nº peldaños	altura base cms	unid. env.	ean
23010110	5	106	1	8 000071 958370
23010115	6	128	1	8 000071 958387
23010120	7	150	1	8 000071 958394

- Homologada EN 131
- Fabricada en aluminio de alta resistencia
- Largueros de mayor grueso
- Peldaños dotados de travesaños de seguridad



MAURER

Taburete plegable

código	medida	unid. env.	ean
23010900	29 x 22 x 39 cms.	10	8 435450 418648
23010905	29 x 22 x 22 cms.	12	8 435450 418655



Plataforma de acero reforzado



Peldaños multiperfil con nervios de refuerzo



Chasis trasero remachado directamente a la estructura principal

ORYX

Escalera aluminio doméstica

código	Nº peldaños	base	unid. env.
23010001	3 Peldaños	61 cms.	1
23010002	4 Peldaños	80 cms.	1
23010003	5 Peldaños	100 cms.	1
23010004	6 Peldaños	118 cms.	1
23010007	7 Peldaños	137 cms.	1
23010010	8 Peldaños	156 cms.	1



8 435231 902328

ORYX

Escalera aluminio uso doméstico

código	descripción	unid. env.	ean
23010015	3 Peldaños	1	8 435231 902380



MAURER

Escalera acero uso doméstico

código	medida	unid. env.	ean
23010106	2 Peldaños	6	8 000071 959797
23010105	3 Peldaños	4	8 000071 959803
23010104	4 Peldaños	3	8 000071 959810



MAURER

Escalera acero Plus uso doméstico

código	medida	unid. env.	ean
23010100	2 Peldaños	2	8 435450 400308
23010102	3 Peldaños	2	8 435450 400315

- Forma anatómica original
- Peldaños engomados de gran dimensión.



Contera rectangular eco

código	descripción	unid. env.	ean
23020124	61	1	3 178740 111205
23020126	66	1	
23020130	78	1	
23020128	86	1	



Conteras goma blister 2 piezas

código	descripción	unid. env.	ean
23020106	5,5 x 2,5	1	3 178740 016418
23020108	6,5 x 3,0	1	3 178740 016432
23020110	8,0 x 3,0	1	3 178740 016463



Contera para escalera aluminio "eco"

código	descripción	unid. env.	ean
23020100	6,3 cms.	1	8 435231 961516
23020102	7,3 cms.	1	8 435231 961523



Conteras escalera parte superior

código	descripción	unid. env.	ean
23020118	Pequeña	1	8 435231 931885
23020122	Grande	1	8 435231 931908



Contera para escalera aluminio "eco"

código	descripción	unid. env.	ean
23020080	Para travesaño horizontal	1	3 178740 024192



Contera para escalera aluminio doméstica / profesional

código	descripción	unid. env.	ean
23010150	Del. Interior 40 x 18	1	8 435231 965880
23010155	Tras. Interior 34 x 18	1	8 000071 611138



Contera escalera telescópica aluminio

código	descripción	unid. env.	ean
23020480	28 x 68 Juego 2 piezas	1	8 435231 946483

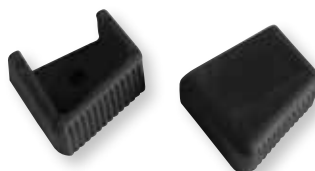

Contera escalera telescópica mixta

código	descripción	unid. env.	ean
23020490	Juego 2 piezas	1	8 435231 936736



Contera escalera pronor para travesaño horizontal

código	descripción	unid. env.	ean
23020082		1	8 435231 947466



Contera escalera travesaño 3 tramos "eco"

código	descripción	unid. env.	ean
23030035		1	8 435450 401954



Contera escalera 0ryx 2016

código	descripción	unid. env.	ean
23010040	delantera	1	8 435450 400353



Contera escalera 0ryx 2016

código	descripción	unid. env.	ean
23010045	trasera	1	8 435450 400360



Contera escalera "eco"

código	descripción	unid. env.	ean
23030020	3 x 7/ 8 24 x 60 mm.	10	8 000071 968096
23030025	3 x 9/10 25 x 65 mm.	1	8 435450 401930
23030030	3 x 9/10 25 x 80 mm.	1	8 435450 401947



Contera escalera doméstica / profesional

código	descripción	unid. env.	ean
23010160	4 piezas	1	3 190190 009000

- Medidas: 33x20 mm. / 40x23 mm.
- Para colocar en las patas delanteras y traseras de las escaleras.



Articulación protectora escalera eco

código	descripción	unid. env.	ean
23020132		1	3 178740 138424



Ganchos no incluidos

Lineal sin ganchos

código	medida	unid. env.	ean
18040005	Papillon 250 x 100 cms.	1	8 000071 556651



Ganchos no incluidos

Lineal sin ganchos

código	medida	unid. env.	ean
18040001	Maurer 250 x 100 cms.	1	8 000071 556637

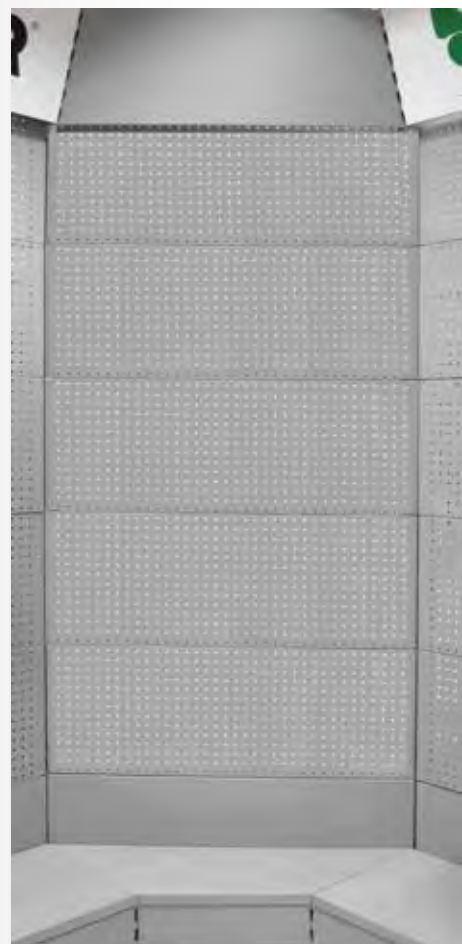

Lineal esquina sin ganchos

código	medida	unid. env.	ean
18040025	250 x 100 cms.	1	8 000071 592466

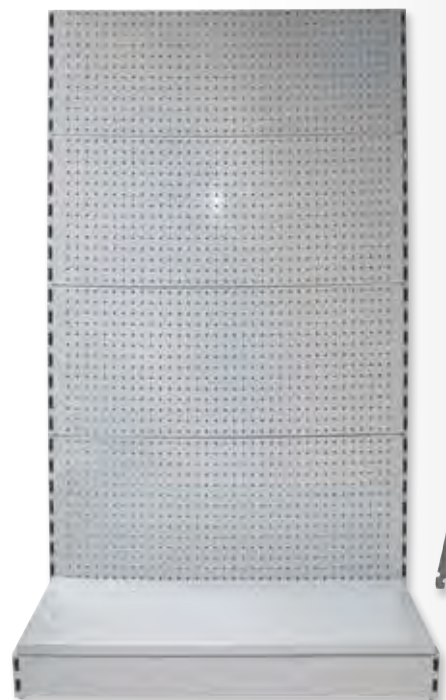

Lineal sin ganchos

código	medida	unid. env.	ean
18040015	150 x 100 cms.	1	8 000071 982375

Valido para:
18040001
18040005
18040015
Incluye soportes



Balda para Lineal

código	medida	unid. env.	ean
18040020	97 x 35 x 3 cms.	1	8 000071 982382



Gancho para lineal D2 con etiquetero

código	unid. env.	ean
18040010	1	8 000071 556675

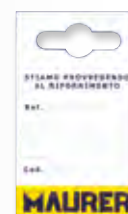

Cartón colgante para lineal fin de existencias

código	unid. env.	ean
18020188	1	8 435231 925860

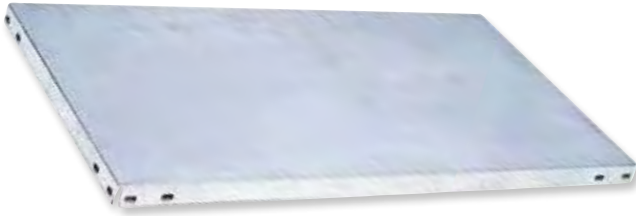

Batea estantería galvanizada

código	medida	unid. env.
21030231	60 x 30 cms.	10
21030232	60 x 40 cms.	10
21030233	60 x 50 cms.	8
21030234	60 x 60 cms.	6
21030236	70 x 30 cms.	10
21030237	70 x 40 cms.	10
21030238	70 x 50 cms.	8
21030241	80 x 30 cms.	10
21030242	80 x 40 cms.	10
21030243	80 x 50 cms.	8
21030244	80 x 60 cms.	6
21030246	90 x 30 cms.	10
21030247	90 x 40 cms.	10
21030248	90 x 50 cms.	8
21030249	90 x 60 cms.	6
21030251	100 x 30 cms.	10
21030252	100 x 40 cms.	10
21030253	100 x 50 cms.	8
21030254	100 x 60 cms.	6

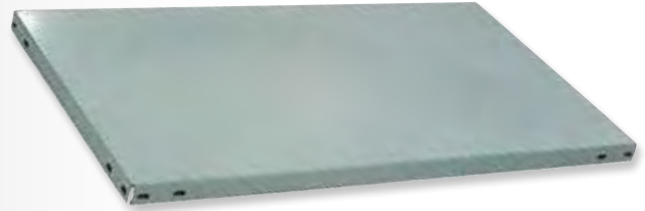

Batea estantería pintada

código	medida	unid. env.
21030201	60 x 30 cms.	10
21030202	60 x 40 cms.	10
21030203	60 x 50 cms.	8
21030204	60 x 60 cms.	6
21030206	70 x 30 cms.	10
21030207	70 x 40 cms.	10
21030208	70 x 50 cms.	8
21030211	80 x 30 cms.	10
21030212	80 x 40 cms.	10
21030213	80 x 50 cms.	8
21030214	80 x 60 cms.	6
21030216	90 x 30 cms.	10
21030217	90 x 40 cms.	10
21030218	90 x 50 cms.	8
21030219	90 x 60 cms.	6
21030221	100 x 30 cms.	10
21030222	100 x 40 cms.	10
21030223	100 x 50 cms.	8
21030224	100 x 60 cms.	6



Perfil estantería galvanizada 40 x 40 mm.

código	medida	unid. env.	ean
21030275	Barra de 2,0 mts.	10	8 425437 001734
21030276	Barra de 2,5 mts.	10	8 425437 001741
21030277	Barra de 3,0 mts.	10	8 425437 001758



Perfil estantería pintada 40 x 40 mm.

código	medida	unid. env.	ean
21030270	Barra de 2,0 mts.	10	8 425437 000331
21030271	Barra de 2,5 mts.	10	8 425437 000348
21030272	Barra de 3,0 mts.	10	8 425437 000355



Escuadra plana bicromatada

código	descripción	unid. env.	ean
21030020	Galvanizada	1.200	8 425437 040764

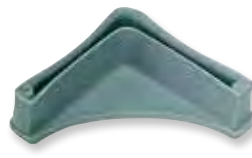

Pies estantería plástico

código	unid. env.	ean
21030025	1.500	8 435231 961851



Tornillo estantería

código	medida	unid. env.	ean
21030015	M - 8 X 16	350	1 000210 300159

Descargate la app



Solicita tus claves



iOS

App Store



Android

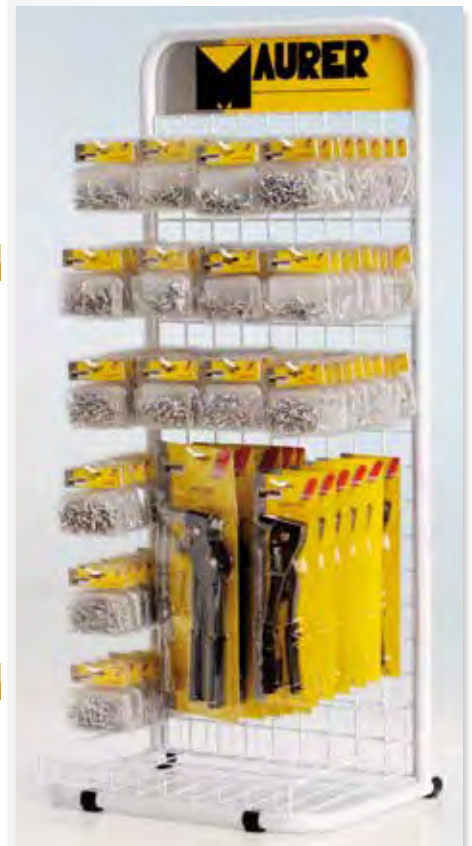

Artículos no incluidos

Expositor metalico hasta 20 kg

código	descripción	unid. env.	ean
18110003	118 x 50 x 40 cms.	1	8 435231 955966

